

# CR-1

Active Subwoofer Crossover

Owner's Manual



**JL AUDIO®**  
*Ahead of the Curve®*

## IMPORTANT SAFETY INSTRUCTIONS

**WARNING:** TO REDUCE THE RISK OF FIRE OR ELECTRIC SHOCK, DO NOT EXPOSE THIS PRODUCT TO RAIN OR MOISTURE.

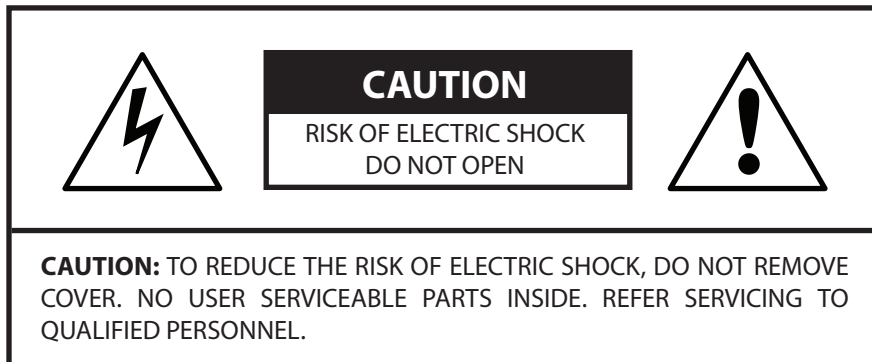

- 1) **Read the Instructions** — All safety and operating instructions should be read before the device is operated.
- 2) **Retain the Instructions** — The safety and operating instructions should be retained for future reference.
- 3) **Heed Warnings** — All warnings on the device and in the operating instructions should be followed.
- 4) **Follow Instructions** — All operating and use instructions should be followed.
- 5) **Water and Moisture** — The device should NOT be used near water – for example, near a bathtub, washbowl, sink, laundry tub, in a wet basement, near a swimming pool, etc.
- 6) **Ventilation** — The device should be situated so that its location or position does not interfere with its proper ventilation.
- 7) **Heat and Flames** — The device should be situated away from heat sources such as radiators, heat registers, stoves, fireplaces, or other devices which produce heat.
- 8) **Power sources** — The device should only be connected to a power supply of the type described in the operating instructions or as marked on the product.
- 9) **Power Cord Protection** — Power-supply cords should be routed so that they are not likely to be walked on or pinched by items placed upon or against them, paying particular attention to cords at plugs, convenience receptacles, and the point where they exit the device.
- 10) **Cleaning** — The device should be cleaned only as recommended in the operating instructions.
- 11) **Nonuse Periods** — The power cord of the device should be unplugged from the outlet when the device is left unused for long periods of time.



*The lightning flash with arrowhead symbol, within an equilateral triangle, is intended to alert the user to the presence of uninsulated “dangerous voltage” within the product’s enclosure that may be of sufficient magnitude to constitute a risk of electric shock to persons.*



*The exclamation point within an equilateral triangle is intended to alert the user to the presence of important operating and maintenance instructions in the literature accompanying the product.*

- 12) Lightning and Power Surges** — To prevent damage due to power surges, we recommend that you disconnect the device from the electrical outlet during electrical storms and/or recurring power interruptions.
- 13) Object or Liquid Entry** — Care should be taken so that objects do not fall into and liquids are not spilled onto the device. Do not expose the device to dripping or splashing from liquids. Do not place objects filled with liquids on top of, or near the device, for example: flower vases, beverages, liquid-fueled lamps, etc.
- 14) Damage Requiring Service** — The device should be serviced by qualified service personnel when:
- a. the power-supply cord or plug has been damaged
  - b. objects have fallen or liquid has been spilled into the device
  - c. the device has been exposed to rain
  - d. the device does not appear to operate normally or exhibits a marked change in performance
  - e. the device has been dropped or has been physically damaged
- 15) Servicing** — The user should not attempt to service the device beyond what is described in the operating instructions. All other servicing should be referred to qualified service personnel.
- 16) Overloading** — Do not overload wall outlets, extension cords, or outlet strips as this can result in a risk of fire or electric shock.
- 17) Grounding** — This device is supplied with a three-prong, grounded power cord. Precautions should be taken so that the grounding means of the device are not defeated. Defeating the grounding prong on the device power cord could increase the risk of electric shock and could result in permanent damage to the device's electronics.

## FCC COMPLIANCE STATEMENT

**NOTE:** This equipment has been tested and found to comply with the limits of Part 15 of the FCC Rules. These limits are designed to provide reasonable protection against harmful interference in a residential installation. This equipment generates, uses and can radiate radio frequency energy and, if not installed in accordance with the instructions, may cause harmful interference to radio communications. However, there is no guarantee that interference will not occur in a particular installation. If this equipment does cause harmful interference to radio or television reception, which can be determined by turning the equipment off and on, the user is encouraged to try to correct the interference by one or more of the following measures:

- Reorient or relocate the receiving antenna.
- Increase the separation between the equipment and receiver.
- Connect the equipment into an outlet on a circuit different from that to which the receiver is connected.
- Consult the dealer or an experienced radio/TV technician for help.

## TABLE OF CONTENTS

Important Safety Instructions: . . . . .	2-3
Introduction: . . . . .	4
Product Overview: . . . . .	5
Package Contents and Placement Considerations: . . . . .	6
Front Control Panel Layout: . . . . .	7
Rear Control and Connections Panel Layout: . . . . .	7
Front Panel Controls in Detail: . . . . .	8-11
Rear Panel Control and Connections in Detail: . . . . .	12-13
Connection Scenarios and Diagrams: . . . . .	14-19
Setup Guides: . . . . .	20-23
Frequently Asked Questions: . . . . .	24
Troubleshooting: . . . . .	24
Limited Warranty / Service Information: . . . . .	25
Installation Notes: . . . . .	26-27
Features and Specifications: . . . . .	28

## INTRODUCTION

Thank you for purchasing a JL Audio CR-1 active subwoofer crossover.

Your CR-1 has been designed in the U.S.A. by a passionate team of audio professionals with vast experience in signal processing and a complete commitment to “ahead of the curve” audio performance.

Please read this manual thoroughly in order to correctly integrate and achieve the highest level of performance with your CR-1. Once your CR-1 is dialed in and you are enjoying new levels of performance from your audio system, you will wonder how you ever lived without one.

**Enjoy.**

## PRODUCT OVERVIEW

CR-1 acts as an audiophile-grade “bridge”, seamlessly connecting a two-channel audio system with a top-flight, powered subwoofer system. Powerful features and a pristine, all-analog signal path make it a key component in optimizing an audio system’s spatial and spectral performance. To minimize distortion and noise, CR-1 employs top-grade component parts in its all-analog audio circuitry: 1% precision resistors, JFET-input audio-grade op-amps, polypropylene film-and-foil capacitors and metallized-polypropylene film capacitors, to name just a few. This attention to component quality makes CR-1 a worthy partner to the finest audio preamplifiers and amplifiers.

CR-1’s input-output design makes it equally adaptable to studio, mastering suite or audiophile, two-channel playback environments. Inputs and outputs are provided for balanced (XLR or 1/4-inch TRS) and unbalanced (RCA) sources. Independent buffering of balanced and unbalanced outputs is employed, to reduce the likelihood of noise. JL Audio’s differential input technology effectively rejects common-mode hum and noise on the unbalanced inputs.

From the CR-1’s stereo inputs, you can derive either a single “mono” (Left + Right) subwoofer signal, or separate signals, for separate left and right subwoofers. A front-panel switch allows you to select between these modes.

The CR-1’s crossover functionality is built around two banks of high precision, low-pass and high-pass Linkwitz-Riley filters. These can be set as 12 dB/octave (moderate cutoff slope) or 24 dB/octave (steeper cutoff slope), via a front-panel switch. For each filter pair, the cutoff frequency is fully variable from 30 Hz – 150 Hz via rotary controls. Behind these knobs, multiplying DACs with monolithic ratio matching are employed to adjust the analog circuit’s filter frequencies. This digitally-controlled, analog filter circuitry allows for high precision in making frequency adjustments and facilitates precise matching between the left and right channels for the ultimate in crossover fidelity and transparency. The CR-1 offers 167 individual cutoff frequency choices between the 30 Hz and 150 Hz limits, in 0.70 Hz steps.

Another of CR-1’s unique and powerful features is the ability to alter the damping behavior of each filter bank. Properly used, the CR-1’s damping controls can improve the acoustic summing through the crossover region, compensating for each speaker system’s frequency response and the way they acoustically interact.

At the center of the CR-1’s front panel, a convenient balance control permits fine level adjustment of the subwoofer and satellite speakers, relative to one another. This is useful for tweaking the sub/satellite balance to compensate for listening conditions or program material, while always being able to easily return to the reference setting. Each of the CR-1’s output channels can also be independently muted via front-panel switches to aid in system setup and troubleshooting.

To facilitate sharing your subwoofer(s) between a home theater system and a dedicated 2-channel system, the CR-1 has a special bypass feature, accessible via a front-panel switch. When this bypass is engaged, the CR-1 will pass signals connected to its dedicated managed bass inputs, completely bypassing the CR-1’s crossover circuitry and level controls. This allows you to use your room’s subwoofers for both 2-channel audio (via the CR-1’s bass management) and multichannel audio (via your pre-pro or receiver’s bass management).

As you can see from this brief introduction, the CR-1 packs a lot of useful technology and functionality. Please read the following sections thoroughly to properly connect and set up your CR-1.

## Package Contents

The CR-1 Active Subwoofer Crossover is shipped from the factory with:

- Owner's Manual
- IEC power cord (3-prong)
- 4 ea. RCA Shorting Plugs
- 2 ea. Rack-mounting ears. *Installation requires the use of a 4mm hex wrench (not included)*

## Placement Considerations :

**Table-Top:** The CR-1 ships from the factory configured as a “table-top” component, including rubber feet. To use it in table-top mode, simply place the unit in your equipment stand where it will be convenient to use and where cable management will be optimized (a significant number of audio cables will typically be connected to the CR-1).

The CR-1 chassis is very robust and can easily support the weight of most source components and signal processors. However, we do not recommend placing heavier equipment, such as amplifiers or receivers directly onto the CR-1. We also do not recommend placing the CR-1 directly on top of a power amplifier or receiver, as the heat generated by those components could affect the CR-1. Whenever possible, place the CR-1 on its own shelf or surface.

**Rack-Mount:** The CR-1 can be rack mounted in a standard 19-inch equipment rack, through the use of the included rack-mount accessory kit. When installed in a rack, the CR-1 occupies two (2) rack-units of space.

### To convert the CR-1 for rack mounting:

1. Unscrew the rubber feet from the bottom of the CR-1.
2. Remove the 4 mm hex-head screws that secure the end covers of the front panel
3. Using the same hex-head screws removed in Step 2, attach the rack ears to each end of the front panel, as shown in the diagram on this page.  
Do not overtighten.
4. CR-1 is now ready to be installed into an equipment rack.
5. To protect the finish of the rack-mount ears, we recommend the use of nylon washers between the rack-mounting screws and the front surface of the rack-mount ears.

We do not recommend rack-mounting the CR-1 directly on top of a power amplifier or receiver, as the heat generated by those components could affect the CR-1.

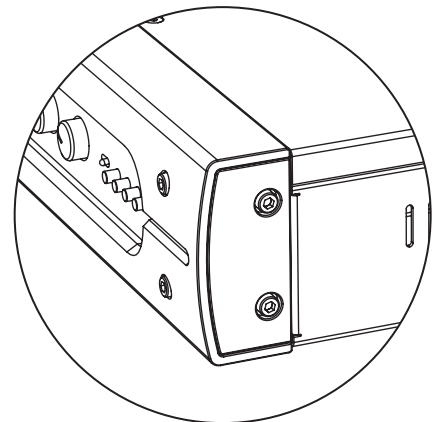

**End Covers**

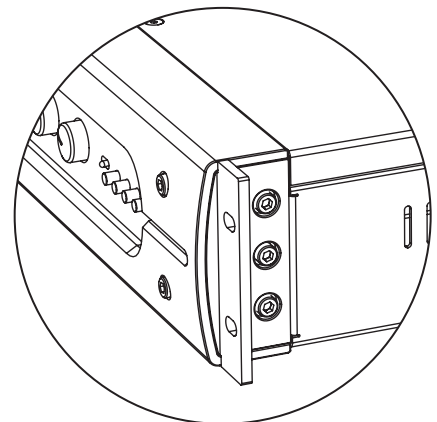

**Rack Ears**

## Front Control Panel

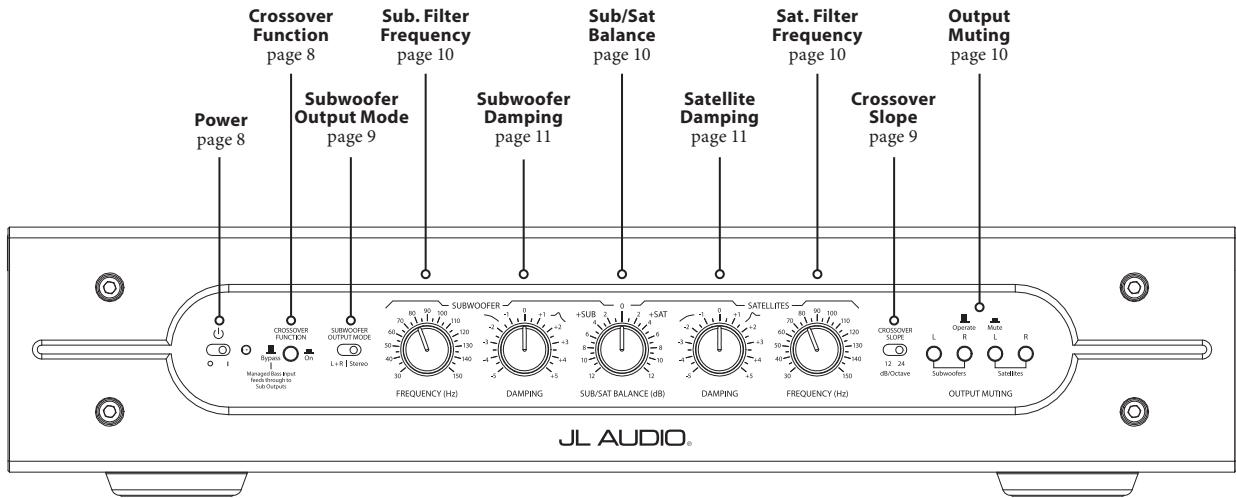



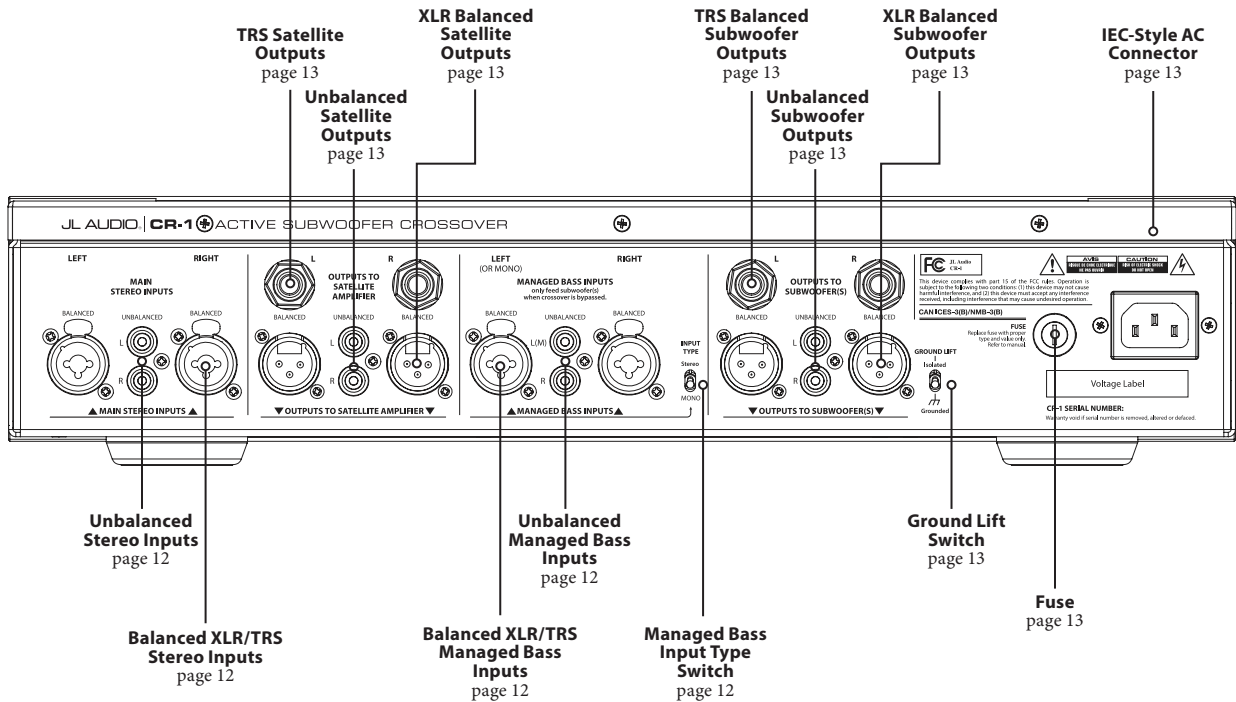

## Rear Controls and Connections Panel



## FRONT PANEL CONTROLS IN DETAIL

### Power switch

The power (  ) switch turns the AC power off (  ) or on (  ). When the power switch is in the “off” mode, it completely interrupts voltage from reaching the CR-1’s circuitry. The LED next to the power switch is unlit when the power is off. When the CR-1’s power switch is in the “on” (  ) position, the CR-1’s circuitry is activated and the LED next to the power switch will light up GREEN. There is no auto turn-on mode.

Because the CR-1 is an audiophile-grade, analog device, its circuitry can benefit from reaching equilibrium after turn-on, much like other high-end audio equipment. After the unit has been off, a brief period of warm up (several minutes) is desirable for best sonic performance. Unless you will not be using the CR-1 for an extended period of time, we recommend that you leave the power switch on. The CR-1 draws a small amount of power when on: approximately 26 watts.

**IMPORTANT:** WHEN THE CR-1 IS “OFF”, SIGNAL WILL BE PASSED DIRECTLY FROM THE “MAIN STEREO INPUTS” TO THE “OUTPUTS TO SATELLITE AMPLIFIER”, WITHOUT FILTERING. THIS ALLOWS YOU TO LISTEN TO YOUR 2-CHANNEL SYSTEM IN FULL-RANGE MODE, WITH NO SUBWOOFER(S), BY SWITCHING THE CR-1 TO “OFF”

### Crossover Function (Bypass) Button

This feature allows you to share one or more subwoofers between separate home theater and dedicated 2-channel stereo systems. This functionality can also allow you to share main left and right loudspeakers between the two setups.

With your 2-channel preamplifier connected to the CR-1’s “**Main Stereo Inputs**”, and your home theater preamp/processor or receiver’s Subwoofer Output connected to the CR-1’s “**Managed Bass Inputs**”, the CR-1 will act as a switch between 2-channel and multi-channel listening modes, via the “**Crossover Function**” switch.

When the Crossover Function is set to “**On**” (Button pressed in, not lighted), the “**Managed Bass Inputs**” are completely disconnected and the CR-1 receives its input signals only from its “**Main Stereo Inputs**” and outputs low-pass-filtered signals via its “**Outputs to Subwoofer(s)**” and high-pass-filtered signals via its “**Outputs to Satellites**”. This is the correct mode for 2-channel listening, and indicates that the CR-1’s active crossover filters are in-line and functioning.

When the “**Crossover Function**” switch is set to “**Bypass**” (button out, lighted red), the CR-1’s “**Managed Bass Inputs**” are connected directly to the “**Outputs to Subwoofer(s)**”. In this “**Bypass**” mode, the CR-1’s “**Outputs to Satellite Amplifier**” will pass signals present at the CR-1’s “**Main Stereo Inputs**”, with no processing. Each left or right RCA input passes signal only to the corresponding left or right RCA output and each XLR/TRS balanced input only sends signal to its corresponding balanced output. All of the CR-1’s crossover functions and level controls are completely bypassed in this mode, meaning that whatever signals are present at the inputs will be passed to the corresponding outputs. Most of the CR-1’s front panel controls are inoperative in this mode. Only the “**Subwoofer Output Mode**” switch and the “**Output Muting**” buttons will remain functional. The primary purpose of the “**Bypass**” mode is to enable your multi-channel receiver or preamp/processor to handle all bass management for your multi-channel system. See Connection Scenario #2 for details on this method (page 22).

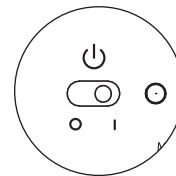

IMPORTANT

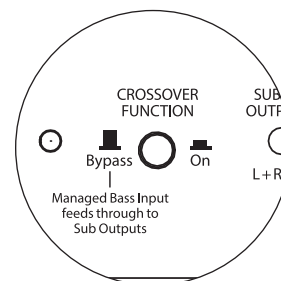



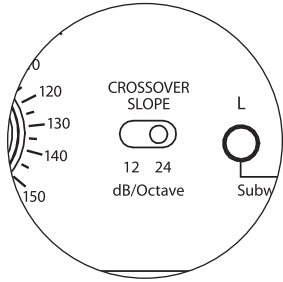
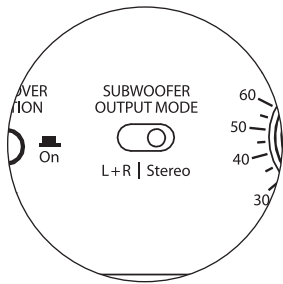

### Subwoofer Output Mode Switch

The “**Subwoofer Output Mode**” switch determines whether the low-pass signal at the subwoofer outputs is in stereo (independent left and right signals), or if both subwoofer outputs deliver a left + right (mono-summed) signal.

If you are using a single subwoofer, set the Mode Switch to “**L+R**” to sum both left and right low-pass signals to mono for the single subwoofer.

If you have a pair of subwoofers, you can decide whether to make them independent, left and right (“**Stereo**” Mode), or make them both output the same mono-summed signal (“**L+R**” Mode). Experiment with both settings to determine which works best in your room for 2-channel and multi-channel playback.

### Crossover Slope Switch

The “**Crossover Slope**” switch changes the attenuation slope of the high-pass and low-pass filters. CR-1 offers a choice between a moderate 12 dB/octave (2nd order) and a steep 24 dB/octave (4th order) slope. A 24 dB per octave high-pass filter attenuates signals below its corner frequency at a rate of -24 dB for every halving of frequency. A 24 dB per octave low-pass filter attenuates signals above its corner frequency at a rate of -24 dB for every doubling of frequency. The 2nd order filter setting attenuates at only -12 dB per octave above or below each filter’s corner frequency. With a steeper roll off slope, there is less “overlap” of acoustical output between the satellite speakers and the subwoofer.

We recommend using the 24 dB/octave slope as a default, as it permits less interaction between the main loudspeakers and subwoofers in the crossover region. The steeper 24 dB/octave filter also does a better job of protecting the main speakers from the effects of low-frequencies that are better handled by the subwoofer(s). There are some uncommon situations where a 12 dB/octave filter may perform better, which is why the CR-1 includes the shallower slope option.

**Effects of “Crossover Slope” Switch (low-pass and high-pass filters are shown)**

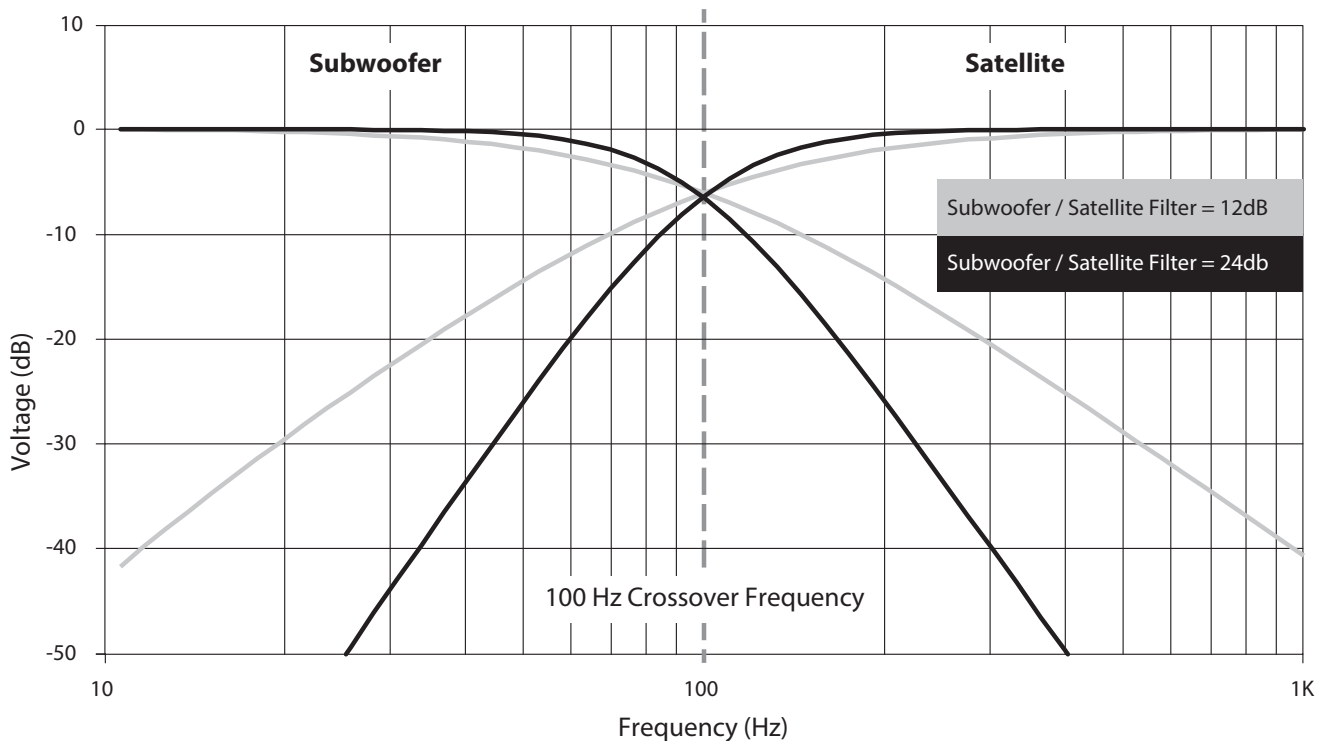

## Frequency Controls

The high-pass and low-pass filters in the CR-1 are designed with a Linkwitz-Riley alignment. This is true for both the 12 dB/octave and 24 dB/octave slopes. In keeping with standard Linkwitz-Riley filter practice, the indicated filter cutoff frequency (aka “corner frequency”) is the -6 dB point, not the -3 dB point. Electrically, when the CR-1’s high-pass and low pass filters are set at the same crossover frequency, their outputs will overlap in the crossover region, summing to a perfectly flat response.

Due to acoustic factors and speaker response deviations, this flat electrical summation may not actually translate to a flat acoustic summation in your room, which is why the CR-1 offers independent “**Frequency**” settings for the high-pass and low-pass filter sections, as well as a pair of very useful “**Damping**” controls (see page 11).

The rotary “**Frequency**” control knob in the Subwoofer Section of the front control panel determines the low-pass crossover filter frequency (in Hertz) that is applied to the subwoofer output signal. The rotary “**Frequency**” control knob in the Satellite Section of the front control panel determines the high-pass crossover filter frequency (in Hertz) applied to the satellite output signal.

CR-1’s ability to “split” the crossover frequencies of the subwoofer and satellites allows for precision system setup within a given acoustic space and subwoofer/satellite system.

## Sub/Sat Balance Control

The “**Sub/Sat Balance**” control knob allows easy, intuitive gain manipulation greatly simplifying level adjustment of your satellites relative to your subwoofer(s). To increase the relative loudness of the satellites, simply turn the “**Sub/Sat Balance**” control clockwise towards the “**+Sat**” end of the control markings. To increase the relative loudness of the subwoofer(s), turn the “**Sub/Sat Balance**” control knob counterclockwise towards the “**+Sub**” end of the control markings.

The “**Sub/Sat Balance**” Control works over a total range difference of +/-12 dB (i.e., the Satellites’ output gain can be adjusted to be up to +12 dB higher than the Subwoofers, or vice versa.) However, to maintain extreme circuit linearity in the CR-1, when you turn the Level Match Control to +2 dB on the Satellite side (i.e., turn up the Satellite level by 2 dB), the circuit actually cuts the Subwoofer output by 1 dB and raises the Satellite gain by only 1 dB, giving you the desired 2 dB difference. Operating in this fashion minimizes the gain envelope of the circuitry and maximizes the sonic transparency of the CR-1.

We recommend that you set up your subwoofer’s gain and your main loudspeaker amplifier’s gain so that you achieve a good reference subwoofer level with the “**Sub/Sat Balance**” control set at “**0**” (12 O’Clock). This way, you can always easily return to your reference level setting.

## Output Muting Buttons

The “**Output Muting**” buttons will “**Mute**” (turn off) the selected satellite or subwoofer output when the button is pressed “in.” In the muted state, the button will light up RED. During normal operation the “**Output Muting**” buttons are unlit.

Output muting can be helpful when troubleshooting or performing measurements on your sound system. Selectively turning your individual speakers “**on**” or “**off**” will help you isolate individual channels or speakers and determine which units are functioning properly and which ones may be having problems.

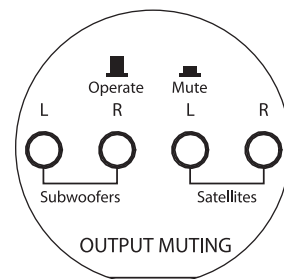
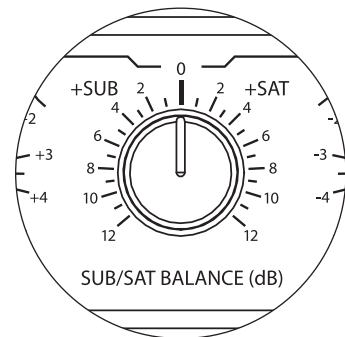
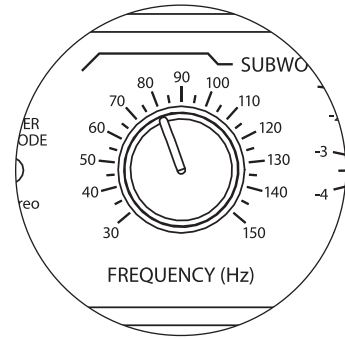

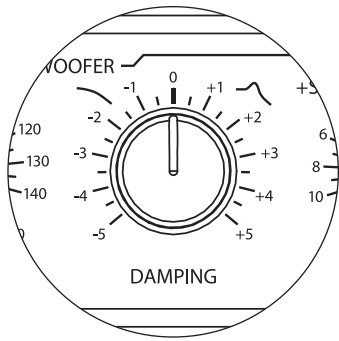

## Damping Controls

There are two “**Damping**” controls on the CR-1, one in the Subwoofer Section and another in the Satellite Section of the front control panel. This precision tuning feature allows you to compensate for loudspeaker response variations in the crossover region. The “**Damping**” controls work by altering the damping of the crossover filters. In technical terms, the controls raise or lower the “**Q**” factor of each filter. However, the number markings on the “**Damping**” controls are for reference only and do not directly refer to any specific “**Q**” value.

In plain language, the Subwoofer and Satellite “**Damping**” controls allow the small frequency ranges around each filter’s initial roll-off region to be boosted (+) or cut (-), outside of the standard Linkwitz-Riley filter alignments. When set correctly, the “**Damping**” controls provide a final “tweak” to an expertly integrated subwoofer system. For best results, the “**Damping**” controls should only be addressed after the subwoofer(s) have been set correctly for polarity and phase (refer to your subwoofer manuals for details).

If the crossover region sounds “thin,” turn the knobs to the right towards the “+” numbers, creating a rise in response near the filter’s cutoff frequency.

If the crossover region sounds “thick” or exaggerated, turn the knobs to the left towards the “-” numbers, creating a softer corner around the filter’s cutoff frequency. See the diagram for a visual explanation of the “**Damping**” controls’ effects.

**Effects of “Damping” controls on frequency response (low-pass and high-pass filters are shown)**

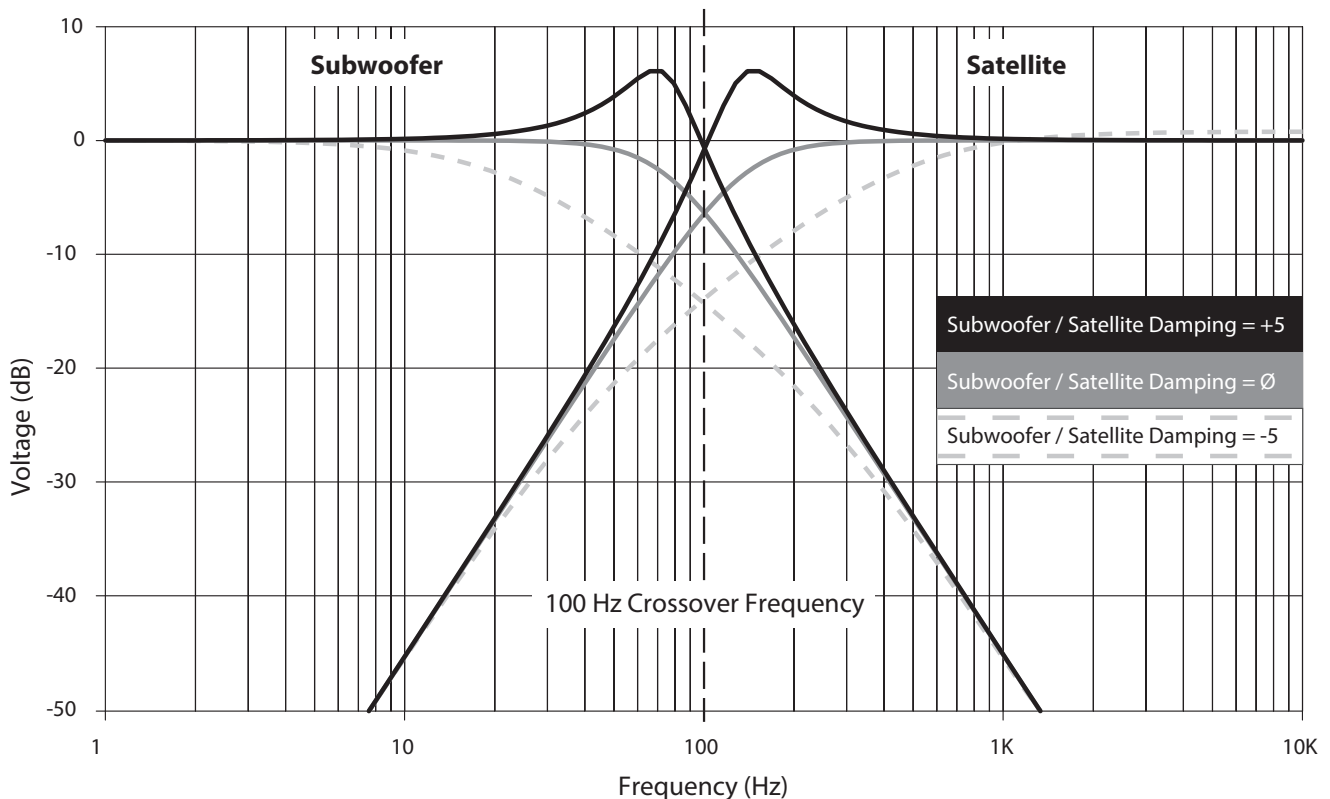

## REAR PANEL CONTROLS AND CONNECTIONS IN DETAIL

### Main Stereo Inputs

The “**Main Stereo Inputs**” receive the primary Left and Right outputs from your 2-channel preamplifier. This is the full-bandwidth stereo signal, which will be split by the CR-1 to feed the satellite amplifier and subwoofer(s).

If your preamplifier only offers unbalanced RCA-type outputs, use RCA-terminated, unbalanced cables connected to the CR-1’s “**Unbalanced**” jacks.

If your preamplifier offers balanced output connections, use balanced XLR or TRS terminated cables, connected to the CR-1’s “**Balanced**” XLR/TRS combo jacks. If the “**Unbalanced**” RCA-type inputs of the CR-1 will remain unused, insert the supplied RCA-type shorting plugs into these jacks, to eliminate the possibility of noise entering open, unbalanced input connections.

Note that all four (XLR/TRS and RCA) “**Main Stereo Inputs**” are separately buffered and can be used independently. It is therefore possible to connect two different preamplifiers to the CR-1’s “**Main Stereo Inputs**”, with one connected to the balanced inputs and another to the unbalanced inputs. As long as only one preamplifier is powered and delivering signal at one time, the CR-1 will behave normally, although it may require some adjustment of the “**Sub/Sat Balance**” control to account for level differences between preamplifiers.

If both connected preamplifiers are on and delivering signals to the CR-1 simultaneously, the CR-1 will not be damaged, but it will sum the balanced and unbalanced input signals together, which may sound very strange.

### Managed Bass Inputs

The CR-1’s “**Managed Bass Inputs**” are designed to receive the subwoofer signal(s) sent by your home-theater receiver or processor, allowing you to share your room’s subwoofers with a multi-channel home theater system.

If the HT receiver/processor only offers unbalanced outputs, use RCA-terminated, unbalanced cables connected to the CR-1’s “**Unbalanced**” RCA-type “**Managed Bass Inputs**”.

If your HT receiver/processor offers balanced output connections, use balanced XLR or TRS terminated cables, connected to the XLR/TRS combo jacks labeled “**Balanced**”. If the “**Unbalanced**” RCA-type “**Managed Bass Inputs**” will remain unused, insert the supplied RCA-type shorting plugs into these jacks, to eliminate the possibility of noise entering open, unbalanced input connections.

When the front panel “**Crossover Function**” switch is in “**Bypass**” mode (switch “out” and red LED indicator lit), the “**Managed Bass Inputs**” are connected directly to the “**Outputs to Subwoofers**” and no signal processing occurs in the CR-1. The signal presented to the “**Managed Bass Inputs**” can be either stereo (independent Left and Right channels) or mono (incoming signal is already a summed (combined) signal for the subwoofer. See “**Input Type**” switch.

**IMPORTANT:** IF YOU FEED ONLY ONE MANAGED BASS INPUT IN THE MONO INPUT MODE, THE SIGNALS ON THE INDIVIDUAL LEFT AND RIGHT SUBWOOFER OUTPUTS WILL BE ONLY HALF THE VOLTAGE LEVEL OF THE INPUT (-6 DB). IF THIS LOSS OF OUTPUT LEVEL POSES A PROBLEM FOR YOUR SYSTEM, USE A Y-ADAPTOR TO SEND YOUR MONO INPUT SIGNAL TO BOTH THE LEFT AND RIGHT MANAGED BASS INPUTS – THIS ALLOWS YOU TO RECOVER THE 6 DB SIGNAL LOSS.

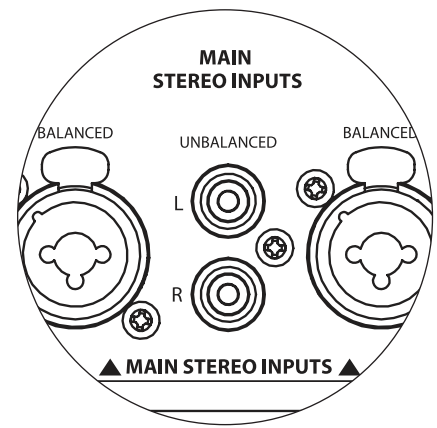

The Balanced Input Connections of the CR-1 utilize Neutrik® Combo XLR/TRS Connectors. These connectors are designed to accept either type of balanced input connector.

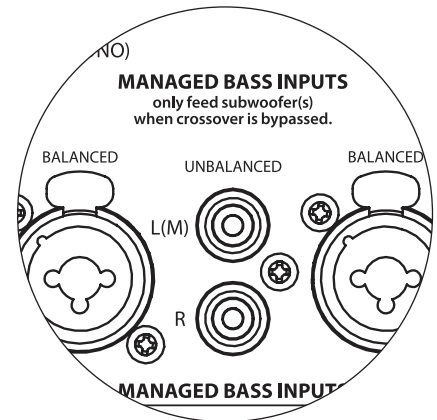

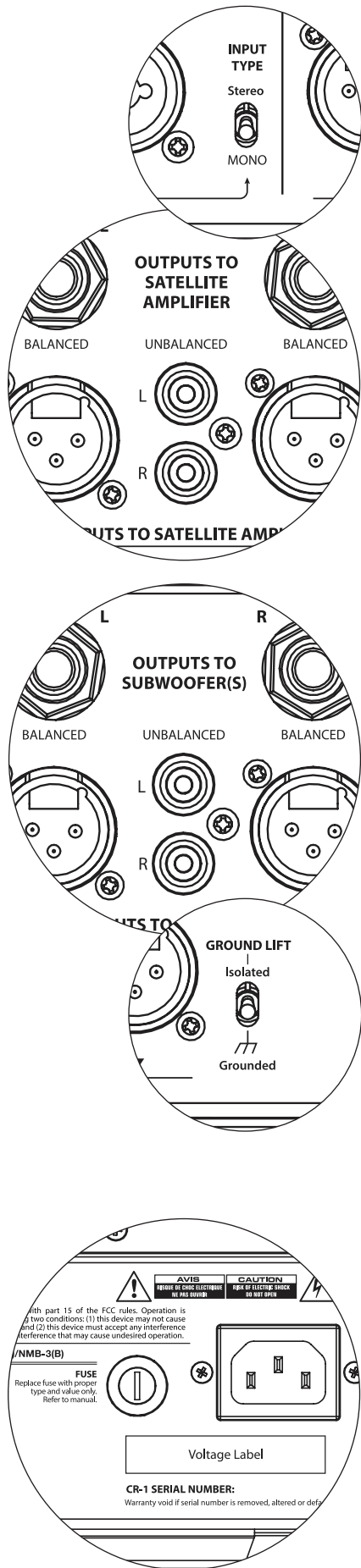

### “Input Type” Switch

Next to the “Managed Bass Inputs” on the rear panel of the CR-1 is the “Input Type” switch, which determines whether the CR-1 maintains incoming signals from your home theater receiver/preamp-processor in stereo (independent Left and Right channels), or whether CR-1 sums independent signals to mono. In “Stereo” mode, the Left Managed Bass Input corresponds directly to the Left Subwoofer Output. The same is true for the Right channel. In “MONO” mode only the “Left (or Mono)” channel is active.

### Outputs to Satellite Amplifier

The “Outputs to Satellite Amplifier” are the primary stereo outputs to the amplifier that drives your Left and Right stereo speakers. These outputs carry the high-pass filtered signal (frequencies ABOVE the crossover frequency) to the satellites. Choose the output type that matches the inputs on your main speaker amplifier. If the amplifier offers both, balanced is the preferred method (XLR or TRS.)

The balanced XLR and TRS outputs share circuitry and both should NOT be used at the same time (choose only one balanced output type). The XLR and RCA outputs have separate buffer amps and can be used at the same time, if desired.

### Outputs to Subwoofers

These are the primary outputs to one or more subwoofers, carrying the low-passed signal (frequencies BELOW the crossover frequency) to the subwoofers.

As with the “Outputs to Satellite Amplifier” (below) the XLR and TRS balanced outputs share circuitry and should not be used at the same time. However, the XLR and RCA outputs have separate buffer amps and can all be used at the same time to feed multiple subwoofers.

### Ground Lift Switch

The Ground Lift Switch “lifts” (isolates) the Pin 1 (shield) ground of the XLR and TRS connectors from chassis ground in the CR-1. This can be useful in solving some noise problems, typically 60 Hz hum. If you do not have any hum noise, leave this switch in the “Grounded” position. Note that if you change any of your audio equipment upstream of the CR-1, you may need to revisit this switch setting for best system noise performance. **This switch will have no effect on unbalanced (RCA) connections.**

### Fuse Holder

The Fuse Holder accepts the properly sized (250 V, 0.50 amp, slow-blow, 5x20 mm cartridge-type) AC fuse. Please call JL Audio Technical Support if your CR-1 will not power up.

### IEC-Style AC Connector

The IEC-Style AC Connector accepts the standard IEC three-prong power cord that is included with the CR-1. ONLY use a three-prong (grounded) power cord with the CR-1. Use of a two-prong plug, or a “cheater plug” may result in damage to the CR-1, which would not be covered under warranty.

## SCENARIO 1:

### 2-channel Subwoofer/Satellite System, Bass-Managed by the CR-1

The CR-1 connects between your 2-channel preamplifier and your 2-channel amplifier as shown in the diagram on the opposing page. These connections can be made via balanced cables (XLR or TRS) or via unbalanced cables (RCA-type) – OR – any combination of these, in pairs.

For example, you may connect your stereo preamplifier's main outputs to the **"Main Stereo Inputs"** of the CR-1 via balanced XLR cables. Then, you can connect the CR-1's **"Outputs to Satellite Amplifier"** to a stereo amplifier via balanced TRS cables, and then connect the CR-1's **"Outputs to Subwoofer(s)"** to the subwoofers using unbalanced RCA cables. The CR-1 gives you unmatched flexibility to interconnect components with various input/output configurations.

Balanced connections generally provide superior noise rejection and ensure proper grounding between components. If your 2-channel preamplifier, amplifier and subwoofer(s) have balanced connections available, we highly recommend that you use them.

Do not mix balanced and unbalanced connections for a given stereo signal pair. The balanced and unbalanced connections have different gains and mixing them within a stereo pair will result in a level imbalance between channels.

If you are using only one subwoofer, set the CR-1's front-panel **"Subwoofer Output Mode"** switch to **"L+R"** (mono). If you are using more than one subwoofer, you may choose **"L+R"** (mono) or **"Stereo"** subwoofer modes depending on your room setup and personal preference.

**IMPORTANT:** WHEN THE CR-1 IS "OFF", SIGNAL WILL BE PASSED DIRECTLY FROM THE "MAIN STEREO INPUTS" TO THE "OUTPUTS TO SATELLITE AMPLIFIER" WITHOUT FILTERING. THIS ALLOWS YOU TO LISTEN TO YOUR 2-CHANNEL SYSTEM IN FULL-RANGE MODE, WITH NO SUBWOOFER(S), BY SWITCHING THE CR-1 TO "OFF"

When the CR-1 is connected as shown in this scenario, the operating modes and behaviors are as follows:

**Power: On and "Crossover Function" switch: "On"**

"Outputs to Subwoofers" are low-pass filtered by the CR-1

"Outputs to Satellites" are high-pass filtered by the CR-1

**Power: On and Crossover Function switch: "Bypass"**

"Outputs to Subwoofers" are off.

"Outputs to Satellites" pass signals directly from "Main Stereo Inputs", unfiltered (full-range).

**Power: Off**

Same as "Bypass" above.



IMPORTANT

# SCENARIO 1 CONNECTION DIAGRAM:

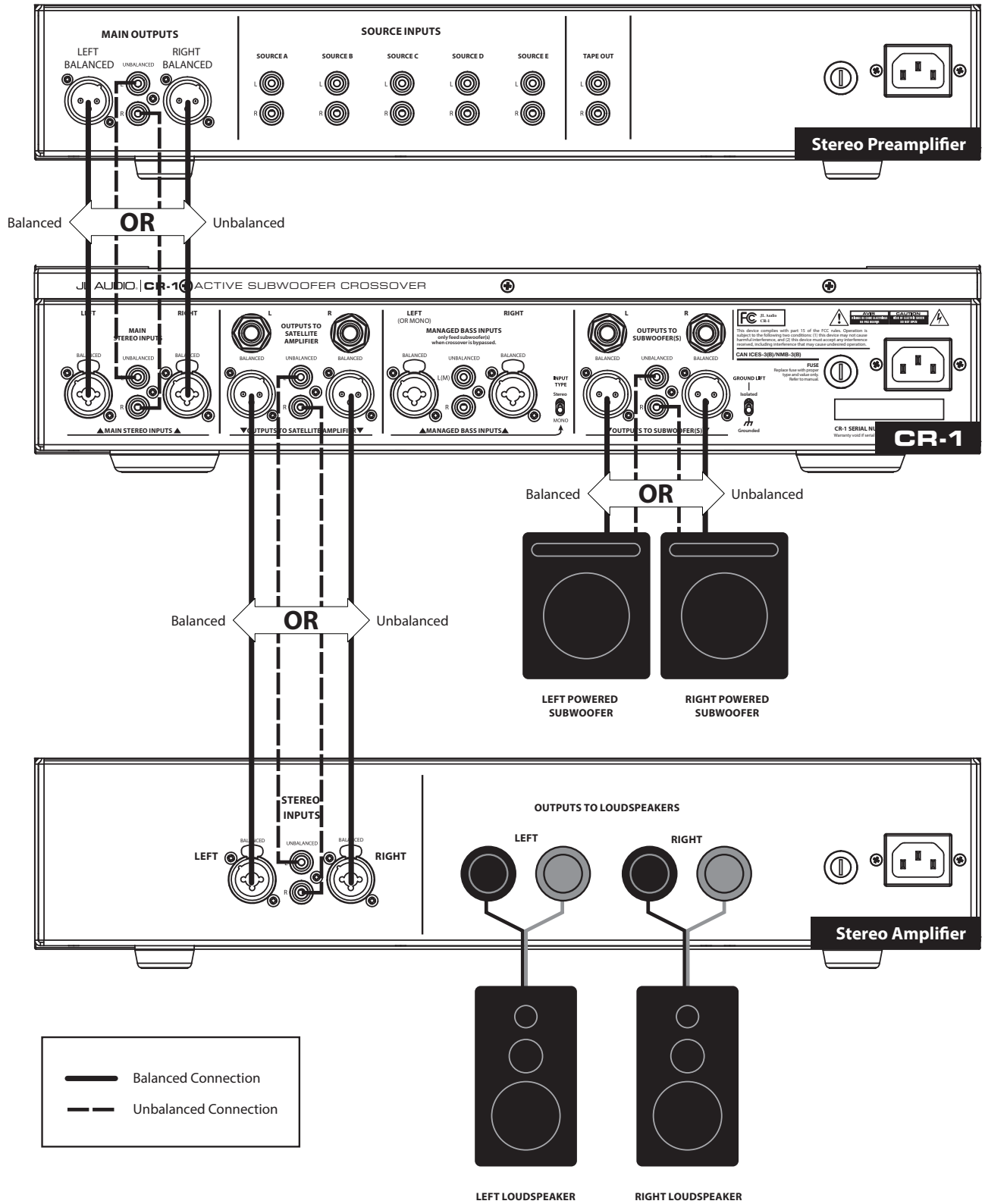

**WARNING! TURN OFF THE CR-1 AND ALL OTHER EQUIPMENT IN THE SYSTEM BEFORE MAKING OR CHANGING ANY CONNECTIONS!**



## SCENARIO 2:

### 2-channel Subwoofer/Satellite System that is Bass-Managed by the CR-1 and also shares active subwoofers with a separate multi-channel home theater system

This scenario shows how you can share your room's subwoofer(s) between a completely separate home theater (HT) and a stereo, 2-channel system. In this scenario, your HT receiver (or amplifier) will power dedicated Left, Center, Right, and surround speakers. A separate, dedicated stereo amplifier will power separate, dedicated stereo Left and Right speakers (not shared with the HT setup.) The subwoofer(s) will be shared between both systems, using the CR-1 as a switch to select the operating mode.

Most HT receivers and preamp/processors provide a single (mono) subwoofer output; however, a few high-end receivers and processors may offer dual subwoofer outputs. For this reason, CR-1 has left and right **"Managed Bass Inputs"**.

The 2-channel amplifier and preamplifier connect to the CR-1 exactly as shown in the diagram at left and as described in Scenario #1, on page 14.

Next, connect the HT receiver's or HT preamp/processor's subwoofer outputs to the **"Managed Bass Inputs"** on the CR-1. You may use XLR (balanced) or RCA (unbalanced) cables to make these connections. Then, set the **"Input Type"** switch located next to the **"Managed Bass Inputs"** to the **"Stereo"** or **"Mono"** position, depending on the output from your HT receiver or HT preamp/processor (this switch will usually be set to **"MONO"**.)

If you connect only one subwoofer signal to the **"Managed Bass Input"**, be sure to use the corresponding Left or Right **"Output to Subwoofer"** on the CR-1. Using the opposite one will result in no subwoofer signal.

If you are using one subwoofer, set the CR-1's front-panel **"Subwoofer Output Mode"** switch to **"L+R"** (mono.) If you are using more than one subwoofer, you may decide whether to choose **"L+R"** (mono) or **"Stereo"** subwoofer modes depending on your room setup and personal preference.

**IMPORTANT:** WHEN THE CR-1 IS OPERATING IN "BYPASS" MODE, THE "SUBWOOFER OUTPUT MODE" SWITCH ON THE FRONT PANEL WILL HAVE NO EFFECT AND THE MANAGED BASS SUBWOOFER SIGNAL FROM YOUR HT RECEIVER OR PREAMP/PROCESSOR WILL BE PASSED THROUGH THE CR-1 WITH NO ALTERATION.

When the CR-1 is connected as shown in this scenario, the operating modes and behaviors are as follows:

**Power: On and "Crossover Function" switch: "On"**

"Outputs to Subwoofers" are low-pass filtered by the CR-1

"Outputs to Satellites" are high-pass filtered by the CR-1

**Power: On and Crossover Function switch: "Bypass"**

"Outputs to Subwoofers" pass signals directly from the "Managed Bass Inputs"

"Outputs to Satellites" pass signals directly from "Main Stereo Inputs", unfiltered (full-range).

**Power: Off**

Same as "Bypass" above.



IMPORTANT



# SCENARIO 2 CONNECTION DIAGRAM:

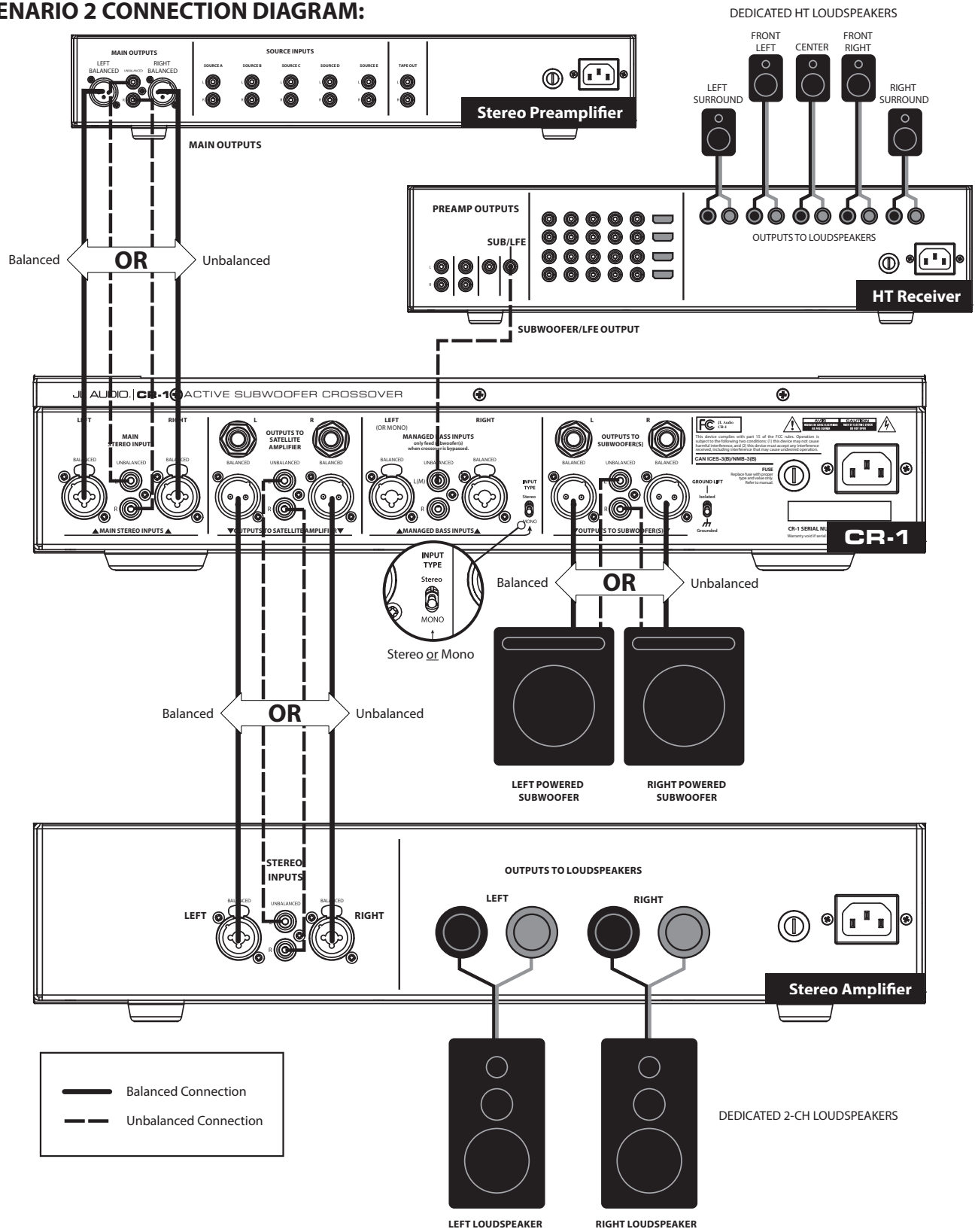

**WARNING! TURN OFF THE CR-1 AND ALL OTHER EQUIPMENT IN THE SYSTEM BEFORE MAKING OR CHANGING ANY CONNECTIONS!**



### SCENARIO 3:

#### 2-channel Subwoofer/Satellite System that is Bass-Managed by the CR-1 and also shares active subwoofers AND MAIN L-R SATELLITE SPEAKERS with a separate multi-channel home theater system

This scenario applies to hybrid home theater / 2-channel setups which will share subwoofers and ALSO share the main left/right loudspeakers. In this setup, your home theater receiver (or amplifier) will power your Center and Surround speakers and pass preamp-level, Left and Right signals to the CR-1. A dedicated, separate stereo amplifier powers the Left and Right speakers for both the multi-channel and the 2-channel system. The subwoofer(s) will also be shared between both systems.

This scenario requires that you connect two different components to the “**Main Stereo Inputs**” of the CR-1. This takes advantage of the CR-1’s independently buffered, balanced and unbalanced input architecture. It is intended that you use only one front-end component at a time: i.e. either your HT receiver - OR - your stereo preamp, not both at once. If you accidentally turn both on, the CR-1 will not be damaged, but it may sound very strange to hear both sources playing at the same time.

The components that will connect to the “**Main Stereo Inputs**” will be your home theater receiver or preamp/processor, and your 2-channel preamplifier. Your home theater receiver must have preamp-level (line-level) outputs for its main left and right channels.

Connect your 2-channel preamp’s Left and Right outputs to the balanced (XLR-type) “**Main Stereo Inputs**” of the CR-1 with the appropriate cables (use RCA to XLR adaptors if necessary.) Then, connect the home theater receiver (the “Bypass component”) to the unbalanced (RCA-type) “**Main Stereo Inputs**” of the CR-1. When in Bypass mode, Satellite signals are passed from input to output ONLY on the same connector types; i.e., from XLR to XLR - or - RCA to RCA. Output-type conversion IS NOT ACTIVE in Bypass mode. Therefore, be sure to connect the “Bypass component” on the RCA inputs.

Similarly, since we want the stereo amplifier that powers the Left and Right shared speakers to work for **BOTH** the stereo system and the home theater system, the stereo amplifier **MUST** be connected to the CR-1 Satellite Outputs **ONLY** on the RCA connectors. Use RCA to XLR adaptors if necessary.

Most home theater receivers and preamp/processors provide a single (mono) subwoofer output; however, a few high-end receivers and processors give you dual subwoofer outputs. Connect the receiver’s subwoofer outputs to the Left and/or Right “**Managed Bass Inputs**” on the CR-1. Then, set the “**Managed Bass Input**” section’s “**Input Type**” switch to the “**Stereo**” or “**MONO**” position, depending on the output from your receiver (this switch will usually be set to “**MONO**”).

If you connect only one subwoofer signal to a “**Managed Bass Input**” on the CR-1, be sure to use the corresponding Left or Right “**Output to Subwoofer**” on the CR-1. If you are using one subwoofer, set the CR-1’s front-panel “**Subwoofer Output Mode**” switch to “**L+R**” (mono.) If you are using more than one subwoofer, you may decide whether to choose “**L+R**” (mono) or “**Stereo**” subwoofer modes depending on your room setup and personal preference.

**IMPORTANT:** WHEN THE CR-1 IS OPERATING IN “BYPASS” MODE, THE “SUBWOOFER OUTPUT MODE” SWITCH ON THE FRONT PANEL WILL HAVE NO EFFECT AND THE MANAGED BASS SUBWOOFER SIGNAL FROM YOUR HT RECEIVER OR PREAMP/PROCESSOR WILL BE PASSED THROUGH THE CR-1 WITH NO ALTERATION.

When the CR-1 is connected as shown in this scenario, the operating modes and behaviors are as follows:

**Power: On and “Crossover Function” switch: “On”**

“Outputs to Subwoofers” are low-pass filtered by the CR-1

“Outputs to Satellites” are high-pass filtered by the CR-1

**Power: On and Crossover Function switch: “Bypass”**

“Outputs to Subwoofers” pass signals directly from the “Managed Bass Inputs”

“Outputs to Satellites” pass signals directly from “Main Stereo Inputs”, unfiltered (full-range signal passes XLR to XLR \*or\* RCA to RCA only).

**Power: Off**

Same as “Bypass” above.



IMPORTANT

# SCENARIO 3 CONNECTION DIAGRAM:

DEDICATED HT LOUDSPEAKERS

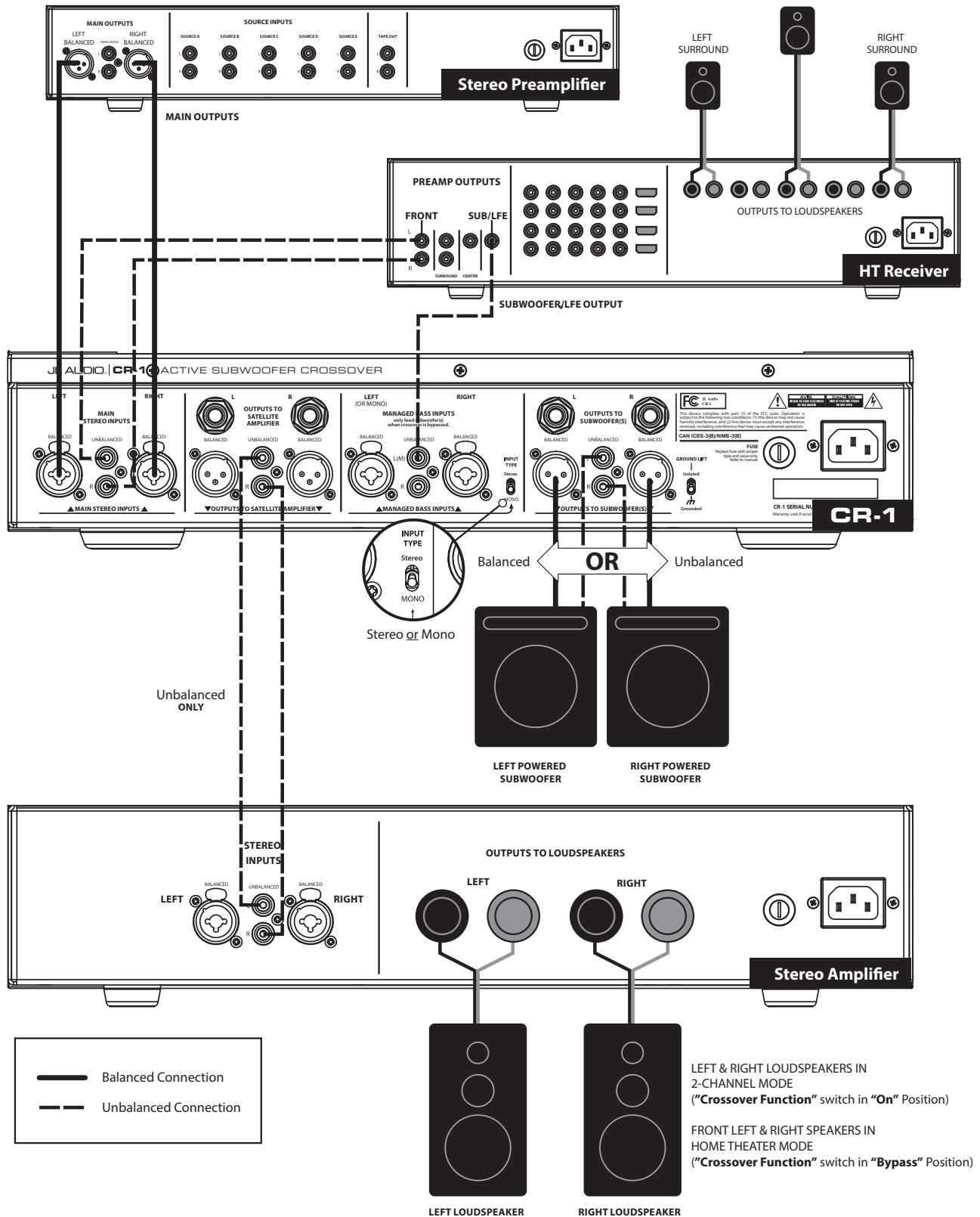

## SCENARIO 1 SETUP GUIDE:

### 2-channel Subwoofer/Satellite System, Bass-Managed by the CR-1

Connect your CR-1 as shown in Scenario 1 Connection Diagram on page 15.

For many 2-channel audiophiles, it is intuitive to select a very low crossover frequency, especially if the satellite (main) speakers are large and capable of good low frequency extension on their own. After all, we have all been taught that subwoofers should be integrated in a manner that they “disappear” acoustically, and that low crossover frequencies are a good way to reach this goal. Unfortunately, this advice is usually **WRONG**.

In light of the above, we will share some very important advice, borne from extensive experience setting up subwoofer/satellite systems in the most demanding applications. An unnecessarily low crossover point (40 Hz, for example) wastes the potential benefit of your subwoofer in most subwoofer/satellite systems. The goal is to unburden your satellites as much as possible, and to pass that low-frequency burden to your subwoofer. Done correctly, the resulting system is more dynamic, more “open” at all frequencies, and will exhibit a wider bandwidth at all listening levels. If you select a very low crossover frequency, you will leave a lot of those performance gains behind.

To get maximum benefit from the integration of a subwoofer (or subwoofers) into your 2-channel audio system, **we recommend crossover frequencies between 60 Hz and 120 Hz, with 80 Hz being an excellent starting point (and often, a very good ending point)**. The CR-1 allows you to select crossover frequencies outside this recommended range in the event of highly unusual system setup requirements.

If you are worried that a higher crossover frequency will lead to easily localizable bass or “disconnected bass”, stop worrying. The CR-1’s powerful features allow for superior integration at any crossover frequency. It is this precise integration that will truly make your subwoofer/satellite seamless and your subwoofers truly “disappear” into the sound stage. The ultimate reward is a remarkably open sound stage, with better imaging and much cleaner dynamics. Really amazing low-frequency qualities will also be evident, with complete unity between subwoofer and satellite outputs.

**To begin setup, set the CR-1’s front panel controls as follows:**

Power: “On”

Crossover Function: “On” (switch pushed “in” with NO red light)

Subwoofer Output Mode: “L+R” (mono sub output)

Subwoofer Frequency: 80 Hz (ideal for many systems)

Subwoofer Damping: “0”

Sub/Sat Balance: “0”

Satellite Damping: “0”

Satellite Frequency: 80 Hz (ideal for many systems)

Crossover Slope: 24 dB/Octave (preferred for most systems)

All Muting switches set to “Operate” (all switches “out” with NO red lights.)

Next, defeat all signal processing on your subwoofer. In other words, turn off any on-board low-pass filtering and defeat any polarity or phase controls, and set the subwoofer's Level control to the middle position. We will first set the CR-1 and then tweak the subwoofer's controls.

Using familiar music with significant mid-bass energy (frequency content that occurs in the crossover region), listen to your system and **adjust your subwoofer's Master Level control** to match the level of the satellites. There should be a smooth audible transition from the mid-bass (from the satellites) into the deep bass (from the subwoofer) with no particular emphasis in either band. Later you can fine tune levels using the CR-1's Sub/Sat Balance control.

Next, play the same music again at an elevated level to assess the dynamic capability of your satellites. With the inclusion of the CR-1, your satellites should exhibit increased dynamic headroom and the midrange should sound more effortless and natural. If your satellites sound strained or exhibit distortion at high levels, try increasing the crossover frequency for both the satellites and the subwoofer (adjust them to the same frequency). If your satellites are particularly small, a 100 Hz crossover frequency may be more appropriate.

If your crossover frequency needs to go above 120 Hz, other aspects of your system may need adjusting, such as speaker placement in the room. After adjustment, your system should sound open and dynamic at a variety of volume levels.

Other adjustments on the CR-1 and your powered subwoofer(s) make it possible to dial in your system's transition from the satellites to the subwoofer in the crossover region and to get the subwoofers dialed in for your room's acoustics. A good, high-resolution, real-time analyzer is very helpful to adjust these controls, but they can also be adjusted by ear.

- A) Crossover Frequency (CR-1 front panel)
- B) Crossover Slope (CR-1 front panel)
- C) Damping (CR-1 front panel)
- D) Polarity (on your powered subwoofer)
- E) Phase (on your powered subwoofer)
- F) E.L.F. Trim (on your Fathom or Gotham powered subwoofer)
- G) A.R.O. (Automatic Room Optimization on your Fathom or Gotham powered subwoofer)

Possible adjustments include splitting the crossover frequencies (a lower crossover frequency for the subwoofer and a higher crossover frequency for the satellites, to further remove excess bass energy) and "**Damping**" control adjustments (essentially mild equalization near the crossover point.) Either of these tweaks may necessitate trimming the overall level of the satellites or subwoofer, which is easily accomplished via the Sub/Sat Balance control. If all of this seems daunting, we recommend that you consult your JL Audio dealer for setup assistance and service.

Resources will be available on the JL Audio website at [www.jlaudio.com](http://www.jlaudio.com), on the CR-1 product page. For detailed information about powered subwoofer setup, you can also download the Fathom, Gotham or E-Sub Owner's Manuals from the JL Audio website. While these manuals are most applicable to JL Audio's powered subwoofers, they also include general information about placement and setup that applies to all subwoofers.

## SCENARIO 2 SETUP GUIDE:

### 2-channel Subwoofer/Satellite System that is Bass-Managed by the CR-1 and also shares active subwoofers with a separate multi-channel home theater system

For this setup discussion, we will assume that your separate home theater system is already working and optimized using the subwoofers you will share with the stereo system and the CR-1. Dedicated stereo speakers that are completely separate from your Home Theater system will be added, along with a stereo preamp, a stereo amplifier, and the CR-1.

**Connect your CR-1 as shown in Scenario 2 Connection Diagram on page 17.**

It is very helpful if your existing Home Theater setup has resulted in Subwoofer Level Controls set at a middle position (“0” on a JL Audio subwoofer’s Master Level) and your home theater receiver or processor’s subwoofer output level is also at a middle-range reference position. This will ensure easier integration of your dedicated stereo system and the CR-1.

If you raise the existing Subwoofer Master Level (on the powered subwoofer) to level match the two-channel system, you will need to LOWER the subwoofer level in your home theater receiver or processor to compensate for this level shift. Likewise, if you lower the Subwoofer Master Level to match the two-channel system, you will need to RAISE the subwoofer level in your home theater receiver or processor to compensate for that level shift. The goal is to find a common setting of the Subwoofer’s Master Level control that works well for both systems – the home theater receiver or processor’s level control is used to offset any level differences that exist. The CR-1’s Sub/Sat Balance control is intended for fine tuning rather than gross level offsets.

First, you will set up the two-channel portion of the system, using the CR-1’s controls. Use the same settings and follow the **exact same procedures listed in Setup Scenario 1** to set up this 2-channel mode.

Once you have completed the 2-channel setup and are happy with the results, switch the CR-1 into **“Bypass”** mode via the front panel switch, and confirm that your subwoofer level played through your home theater receiver or processor is still correct. As mentioned above, your 2-channel system’s subwoofer level will be determined only by the Subwoofer’s Master Level control. Your HT receiver or processor’s subwoofer level will adjust the output for multi-channel mode. If needed, adjust the home-theater mode’s subwoofer level via the HT receiver or processor.

Once the above is accomplished, your Home Theater system should sound normal when the CR-1 is in Bypass mode AND your two-channel subwoofer/satellite system should sound fantastic as well. The CR-1 has successfully allowed you to share subwoofers between two different systems with the push of one button.

### **SCENARIO 3 SETUP GUIDE:**

#### **2-channel Subwoofer/Satellite System that is Bass-Managed by the CR-1 and also shares active subwoofers AND MAIN L-R SATELLITE SPEAKERS with a separate multi-channel home theater system**

For this setup discussion, we will assume that your separate home theater system is already working and optimized using the subwoofers and main speaker you will share with the two-channel system via the CR-1. This setup assumes that the home theater's main speakers are driven from an outboard, dedicated amplifier. A stereo preamplifier and the CR-1 will be added to the system to create a dedicated two-channel mode.

**Connect your CR-1 as shown in Scenario 3 Connection Diagram on page 19.**

It is very helpful if your existing Home Theater setup has resulted in Subwoofer Level Controls set at a middle position ("0" on a JL Audio subwoofer's "Master Level") and your home theater receiver or processor's subwoofer output level is also at a middle-range reference position. This will ensure easier integration of your dedicated stereo system and the CR-1.

For your Home Theater System, if you raise the existing Subwoofer Master Level (on the powered subwoofer) to level match the 2-channel system, you will need to LOWER the subwoofer level in your home theater receiver or processor to compensate for this level shift. Likewise, if you lower the Subwoofer Master Level to match the 2-channel system, you will need to RAISE the subwoofer level in your home theater receiver or processor to compensate for that level shift. The goal is to find a common setting of the Subwoofer's Master Level control that works well for both systems – the home theater receiver or processor's level control is used to offset any level differences that exist. The CR-1's Sub/Sat Balance control is intended for fine tuning rather than gross level offsets.

First, you will set up the two-channel portion of the system, using the CR-1's controls. Use the same settings and follow the **exact same procedures listed in Setup Scenario 1** to set up this two-channel mode.

Once you have completed the two-channel setup and are happy with the results, switch the CR-1 into "**Bypass**" mode via the front panel switch, and confirm that your subwoofer level and Left/Right satellite levels played through your home theater receiver or processor is still correct. As mentioned above, your 2-channel system's sub level will be determined only by the Subwoofer's Master Level control. Your HT receiver or processor's subwoofer level will adjust the output for multi-channel mode. If needed, adjust the home-theater mode's subwoofer level via the HT receiver or processor. You may also need to use the HT receiver or processor's Left/Center/Right/Left Surround/Right Surround Level controls to properly rebalance the shared Left and Right speakers with the home theater system.

Once the above is accomplished, your Home Theater system should sound normal when the CR-1 is in Bypass mode AND your two-channel subwoofer/satellite system should sound fantastic as well. The CR-1 has successfully allowed you to share subwoofers between two different systems with the push of one button.

## FREQUENTLY ASKED QUESTIONS

### How are the CR-1's balanced connection wired?

All CR-1 balanced connectors are configured according to Audio Engineering Society recommendations for balanced signal cables as follows:

#### **XLR Connection**

Pin 1: Chassis Ground

Pin 2: Positive

Pin 3: Negative

#### **TRS connection:**

Tip: Positive

Ring: Negative

Sleeve: Chassis Ground

### Will my electric bill be high if I leave the CR-1 on all the time to maximize its fidelity?

When turned "on" the CR-1 draws 26 watts of power, whether it is idling or receiving signals. The CR-1 only requires a short period of warm up to arrive at full performance (2-3 minutes), and it can be used during the warm-up period, if desired.

### Should I unplug my CR-1 during a thunderstorm or extended absence?

During a storm, or extended absence from your home, it is a good idea to unplug all of your audio / video components to prevent damage from unexpected storms or adverse power line conditions.

### How should I clean the CR-1?

For routine cleaning, the CR-1 should be dusted and wiped with a dry, non-abrasive, microfiber cloth. Do not use water to clean the CR-1, nor any harsh chemicals.

## TROUBLESHOOTING

### CR-1 is plugged into a power outlet but will not turn on (no lights at all.)

#### What should I do?

1. Try plugging the CR-1's power cord into a known-good AC power outlet.
2. If the above does not help, remove the Fuse cover on the rear of the CR-1 and see if the fuse is blown. If the fuse is blown, contact JL Audio's Home Technical Support Dept.

### My system has "hum" or power line noise. What should I do?

1. On the CR-1's rear panel, try changing the setting of the Ground Lift switch. Note that this switch is only effective if you are using XLR (or TRS) balanced cables - the Ground Lift switch does NOT affect the RCA jacks.
2. Turn off all audio equipment. Disconnect the components directly ahead of the CR-1. Turn on the CR-1 and all components after it in the signal chain. If the noise stops, the noise source is before the CR-1. Then add one component back to the system at a time until you find the source of the noise.
3. If neither solution above works, try changing cable types (from XLR to RCA, or vice versa.) Some combinations of components may have less noise with an alternate connection type.



## LIMITED WARRANTY / SERVICE INFORMATION

JL AUDIO warrants this product to be free of defects in materials and workmanship for a period of **three (3) years** from the original date of purchase.

Damage caused by the following is not covered under warranty: accident, misuse, abuse, product modification or neglect, failure to follow installation instructions, unauthorized repair attempts, misrepresentations by the seller. This warranty does not cover incidental or consequential damages and does not cover the cost of removing or reinstalling the unit(s) or shipping the unit(s) to JL Audio for service. Cosmetic damage due to accident or normal wear and tear is not covered under warranty.

This warranty is not transferable and applies only to the original purchaser of the product from an authorized JL AUDIO dealer. Warranty is voided if the factory-applied product serial number is removed or defaced.

Should service be necessary under this warranty for any reason due to manufacturing defect or malfunction, JL AUDIO will, at its discretion, repair or replace the defective product with new or remanufactured product at no charge.

Any applicable implied warranties are limited in duration to the period of the express warranty as provided herein beginning with the date of the original purchase at retail, and no warranties, whether express or implied, shall apply to this product thereafter. Some states do not allow limitations on implied warranties, therefore these exclusions may not apply to you. This warranty gives you specific legal rights, and you may also have other rights which vary from state to state.

WARNING



**WARNING:** THIS PRODUCT CONTAINS NO USER-SERVICEABLE PARTS. PRODUCT IN WHICH DISASSEMBLY, REPAIR AND/OR MODIFICATION HAS BEEN ATTEMPTED BY UNAUTHORIZED PARTIES WILL NOT BE COVERED UNDER WARRANTY.

### **If you need service on your JL AUDIO product:**

All warranty returns should be sent to JL AUDIO freight prepaid through an authorized JL AUDIO dealer and must be accompanied by proof of purchase (a copy of the original sales receipt.) Direct returns from consumers or non-authorized dealers will be refused unless specifically authorized by JL AUDIO with a valid return authorization number. Warranty expiration on products returned without proof of purchase will be determined from the manufacturing date code. Coverage may be invalidated as this date is previous to purchase date. Return only defective components. Non-defective items received will be returned freight-collect. Customer is responsible for shipping charges and insurance in sending the product to JL AUDIO. Freight damage on returns is not covered under warranty. Always include proof of purchase (sales receipt).

### **For Service Information in the U.S.A. please call:**

JL Audio customer service:

(954) 443-1100 during normal business hours (Eastern Time)

JL Audio, Inc • 10369 North Commerce Parkway, Miramar, FL 33025

### **International Warranties:**

Products purchased outside the United States of America are covered only by that country's distributor and not by JL Audio, Inc.

# INSTALLATION NOTES

Use this diagram to document your CR-1's inputs/outputs and switch/control positions.

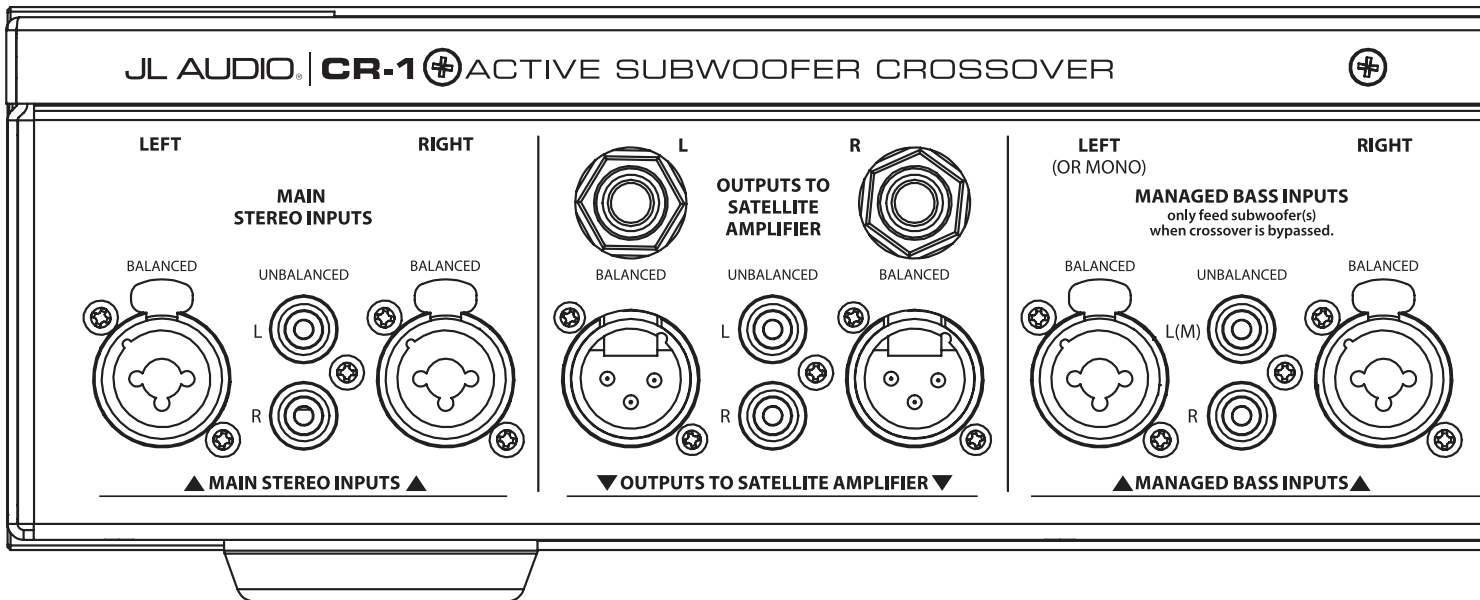
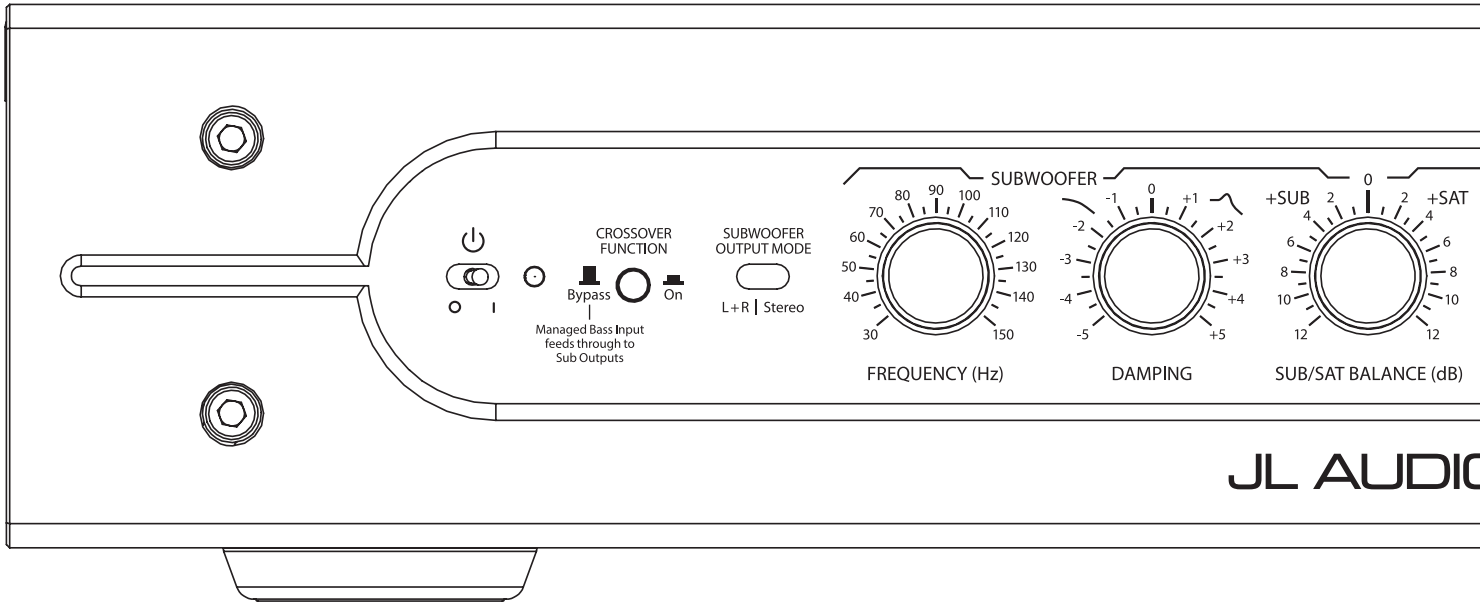

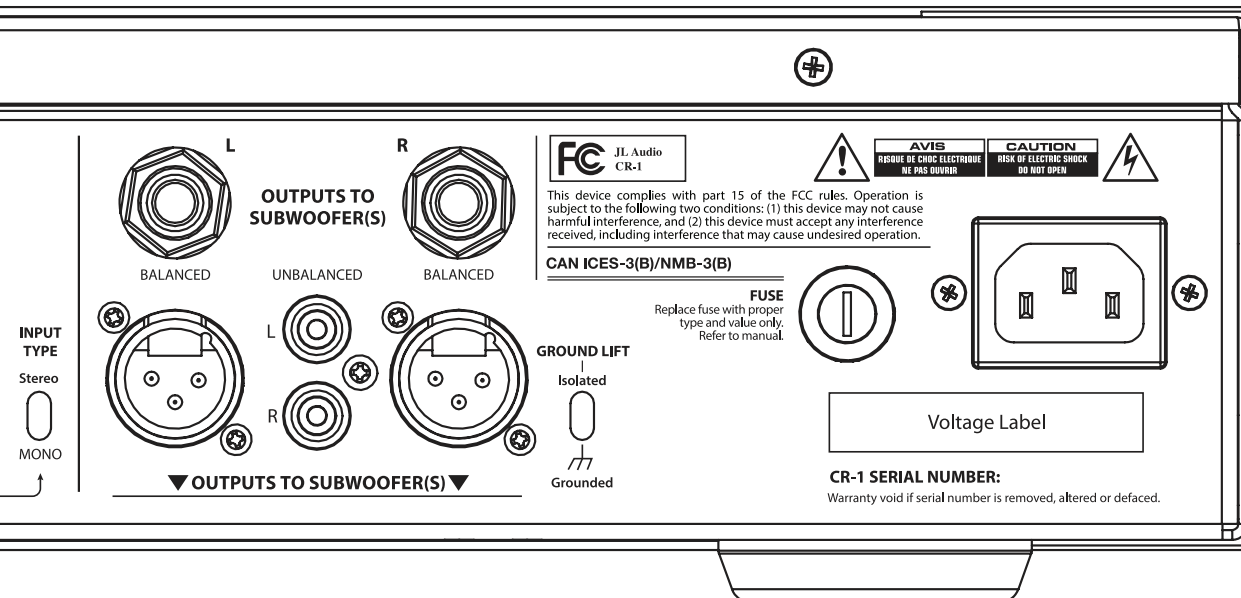
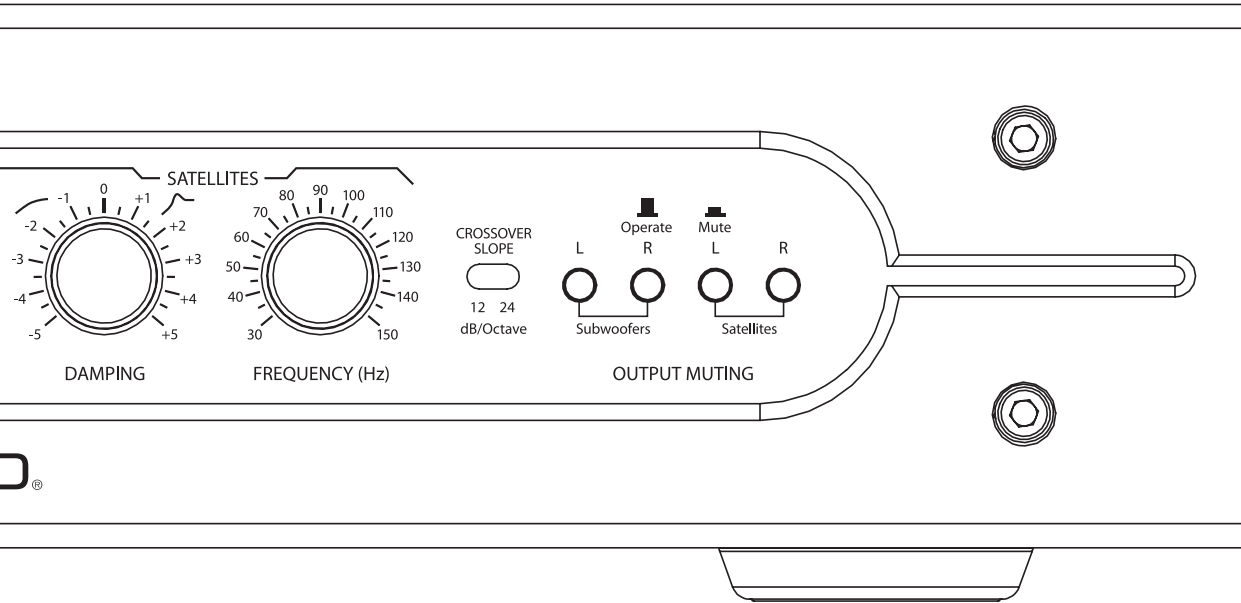

## FEATURES

### Power Modes:

Off/On, selectable via front panel switch

### Crossover Function:

Bypass or On, selectable via front panel switch

### Subwoofer Output Modes:

Mono L+R or Stereo, selectable via front panel switch

### Crossover Frequency Range:

30 Hz – 150 Hz, variable with independent high-pass and low-pass filter frequency controls on front panel

### Crossover Slopes:

12 dB/octave or 24 dB/octave, Linkwitz-Riley, selectable via front panel switch

### Subwoofer/Satellite Balance Control:

+/- 12 dB, fully variable via front panel knob

### Filter Damping Controls:

Q: 0.3 - 1.4 @ 12 dB/octave, via front panel knob

Q: 0.16 - 4.0 @ 24 dB/octave, via front panel knob

For either slope, Q = 0.5 at top dead center "0" mark

### Output Muting:

independent for each output, via front panel push-button switches

### Ground Lift (Balanced Connections):

Isolated/Grounded, via rear panel switch

Specifications	CR-1
Maximum Input Voltage:	8 Vrms (+18 dBV)
Input Impedance:	Unbalanced: 50 kΩ Balanced: 20 kΩ
Maximum Output Voltage:	8 Vrms (+18 dBV)
Output Impedance:	Unbalanced: 150 Ω Balanced: 300 Ω
THD + Noise:	< 0.002% at 8 Vrms/10 kΩ 20 Hz - 20 kHz, 90 kHz bandwidth
Signal to Noise Ratio:	>115 dB, referred to rated output voltage
Channel Separation:	80 dB at 1 kHz, typical
Low Pass Frequency Response:	+0, -1 dB from 5 Hz to 1/4 of filter frequency
High Pass Frequency Response:	+0, -1 dB from 4x filter frequency to 80 kHz
Power Consumption:	30 Watts (typical, with or without signal)
Mains Voltage (Frequency):	120V (60 Hz) or 230/240V (50 Hz or 60 Hz), factory-set for destination country (see back panel of CR-1)
<b>Table-Top</b> Dimensions: (H) Height x (W) Width x (D) Depth	3.80 in x 17.40 in x 15.67 in 97 mm x 441 mm x 398 mm
<b>Rack-Mount</b> Dimensions: (H) Height x (W) Width x (D) Depth	3.46 in x 19.07 in x 15.67 in 88 mm x 484 mm x 398 mm

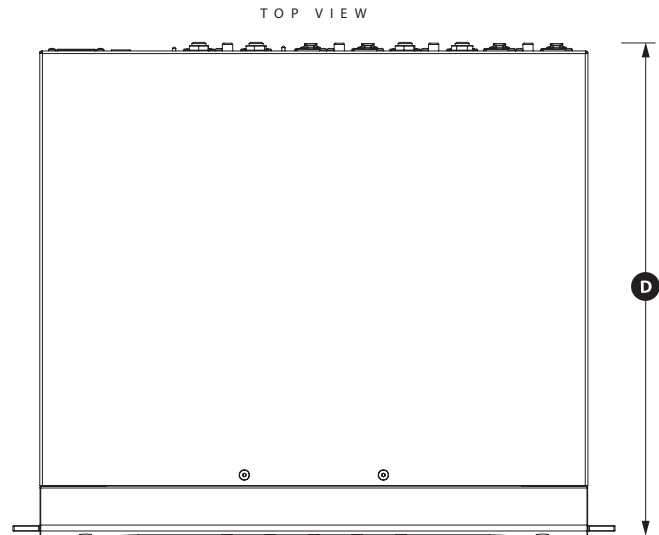
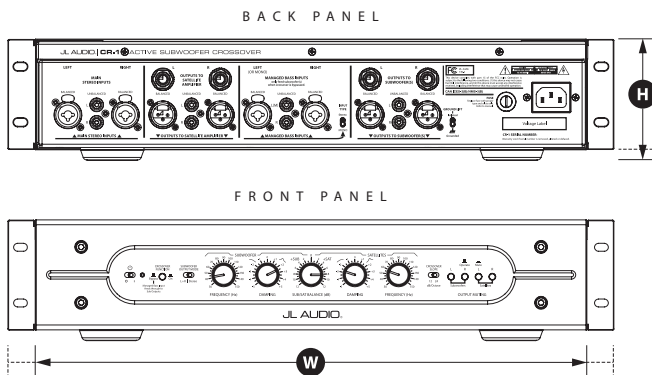

"JL Audio", "Ahead of the Curve" and the JL Audio logo are registered trademarks of JL Audio, Inc. • ©2016 JL Audio, Inc. • U.S. PATENTS: #5,734,734 #5,949,898 #6,118,884 #6,229,902 #6,243,479 #6,294,959 #6,501,844 #6,496,590 #6,441,685 #5,687,247 #6,219,431 #6,625,292 #D472,891 #D480,709 • Other U.S. & Foreign patents pending. For more detailed information please visit us online at [www.jlaudio.com](http://www.jlaudio.com). Due to our policy of continuous product development, all specifications are subject to change without notice.

[www.jlaudio.com](http://www.jlaudio.com)

10369 North Commerce Parkway • Miramar, Florida • 33025 • USA



SKU#97262 04-07-16  
Printed in China